



Sundolitt Kub[®]

Assembly Instructions - January 2019



Content overview

What you will need	2
Overview of elements of the Kub® system	3
General / planning	4
Groundwork / foundation	5
Building the wall, base cap mouldings	6
Reinforcing the Kub® wall	8
Reinforcement when backfilling	9
Reinforcing supportive walls and beams	10
Shoring the wall / casting	11
Supplementary work	12
Remember this!	14
Quantity calculations concrete, iron etc.	15

What you will need

Tools:

Hammer, folding rule, chalkline, tape measure, automatic level (optical), jigsaw, knife, hand saw, level, aviation snipper/hacksaw, drill, hand-held circular saw, angle grinder, tinsnip, hole saw kit.

Timber:

Hardwood mouldings for door and window openings, 48x198mm. Shoring for the wall 48x98mm. Plywood plates 18mm for reinforcement during cutting of the elements.

Concrete:

See page 11 for details around casting.

Reinforcement:

10mm and 12mm rebar. Usage described on page 8-10. Use an online quantity calculation program.

Fixing means:

Nails 6" for the wooden frame of door/window openings. Wooden screws of at least 140mm for fastening the 48x98mm shoring.

Elementes of the Kub[®] system

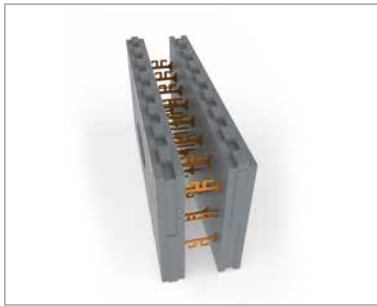

Sundolitt Kub[®] U17 Straight element

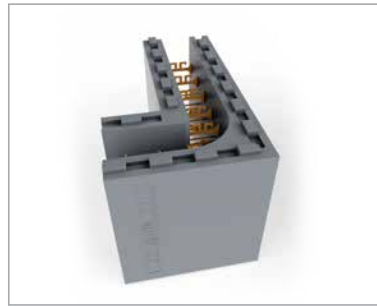

Sundolitt Kub[®] U17 Outer corner



Sundolitt Kub[®] Footing



Sundolitt Kub[®] U11 Straight element

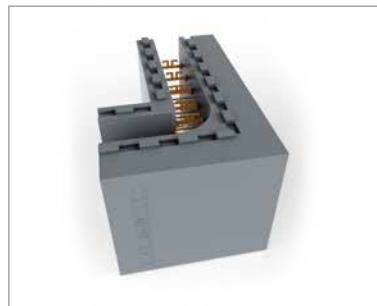

Sundolitt Kub[®] U11 Outer corner

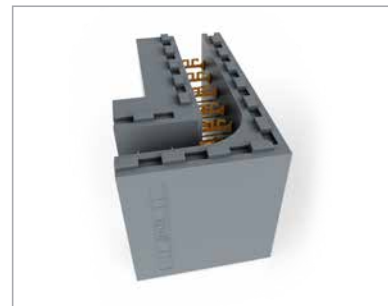

Sundolitt Kub[®] U11 Inner corner



Sundolitt Kub[®] U17 Frame element



Sundolitt Kub[®] U11 Frame element



Sundolitt Kub[®] Top strips



Sundolitt Kub[®] U17 End block



Sundolitt Kub[®] U11 End block

General / planning

The Kub® insulating building system is used for foundations and walls for small houses with up to 2 floors above the terrain. Clarify in advance the wall height, the height of the backfilling of any supporting walls or beams. Please read the entire assembly instructions before starting the work. The product has technical approval and this can be used as a basis for designing buildings. TG 2216.

Example of height calculation I

+ 5 x Kub® elements	3000 mm
+ 1 x Foundation block	290 mm
= Total height	3290 mm
- Crushed rock/gravel filling	450 mm
- Insulation S80	300 mm
- Concrete plate/flooring	100 mm
- Ceiling	40 mm
= Net interior height	2400 mm

Example of height calculation II

2 x Compensation list	150 mm
+ 4 x Kub® elements	2400 mm
+ 1 x Foundation block	290 mm
= Total height	2840 mm
- Footing inner side/ insulation 80	300 mm
- Concrete plate/flooring	100 mm
- Ceiling	40 mm
= Net interior height	2400 mm

As shown on the illustration to the right.

Height calculation:

The number of elements height-wise should be calculated in advance. The elements have a height of 600mm each. If needed, elements with a height of 300mm can be delivered, either for the top or the bottom. Top strips can also be used at the top for adjusting the height.

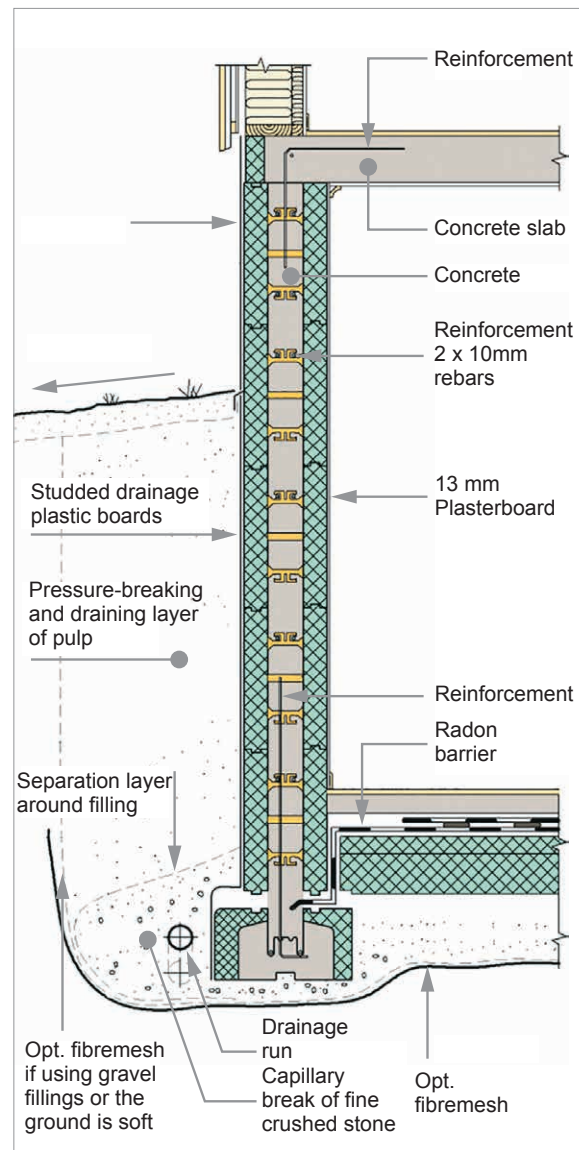

Groundwork / foundation

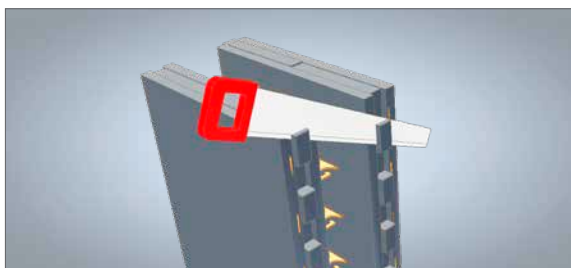
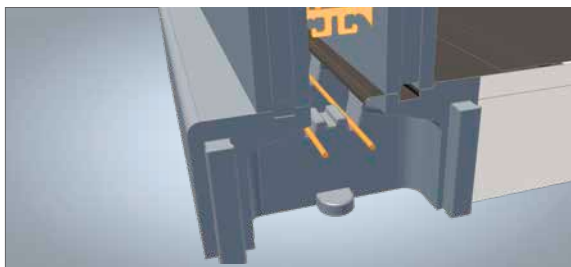
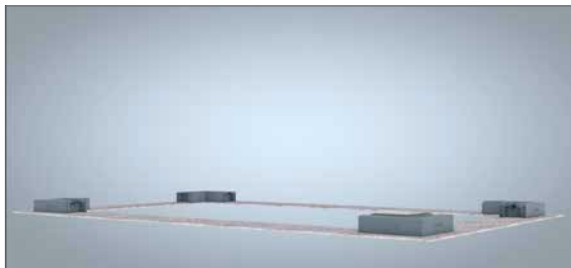

Groundwork:

The lot is dug and levelled normally. Insert hoses for water, drainage and electricity. Level and compress the foundation to the correct height. The levelling should be within +/- 5 mm.

Foundation:

The Sundolitt Footing, which is adapted to KUB®, should be used. Start by assembling the corners of the regular foundation elements by cutting their edges according to the marks (45 degrees). They are assembled with locking brackets and are placed as you go along. There may be both internal and outside corners, according to the layout of the house.

When the corners are in place, the long sides are next. Measure the lengths and cut the last adjustment element carefully. Use mounting brackets where they are cut. The Sundolitt Footer block is reinforced with 2 pcs. 12 mm re-bars. The blocks are corrected height- and lengthwise, and the diagonal measurement is controlled. The supportive reinforcement is carried out just like for a traditional foundation, described below.

NB! The curved edge of the Footing block shall always face outwards, and the shingle shall be raked towards it, both on the outside and the inside, in order to secure its position and strength before casting.

Radon membrane:

The foundation is adapted for inserting a membrane. Place it between the foundation and the 1. Kub® element at the innervang. Insertion around 40 mm past the inner stringer in order to ensure contact with the concrete. A strip is first used as insertion between the foundation and the 1. Kub®-element. When Sundolitt EPS insulation is placed on the site, the radon membrane can be placed here and fastened/glued together with the strip that was initially installed. The membrane can be placed in the insulation layer or over/under the concrete plate. See separate assembly instruction.

Traditional foundation:

A traditional foundation can also be cast as a concrete screed. Supportive reinforcement in the foundation c/c 500 mm, minimum 120 mm down into the foundation and around 600 mm above, Ø12 mm.

NB! The knobs below the Kub®-elements in the first shift must be removed if casting a traditional foundation instead of a foundation block. Before casting Kub on a traditional sole, support on each side is needed with wood lumber 48x48 mm.

Building the wall

Start by placing all corner blocks. These are reversible and are stacked oppositely for every shift in order to ensure overlap.

Assemble the correct element and adjust it towards a corner. At least two plastic rods on the gauge blocks. Adjust the next shift towards the same corner. You can also build from the corners and cut wherever the interior wall will be. Most important is that the screw attachment of the KUB wall is positioned correctly with regards to i.e. assembling plasterboards of a certain width. The screw attachments of the Kub® wall are placed with c/c 150 mm.

Insert reinforcement in every shift. 2x10 mm rebar. Around cut-outs 2x12 mm rebar, anchorage length 500 mm on every side. Reinforcement overlap must be stacked on top of each other and fastened together.

Remember supportive reinforcement from the foundation and up into the wall as described on page 5 and 8. If there is any need for reinforcement at the bottom area of the elements, these are threaded in from the site or lifted up from below.

PS! In the corner elements the bottom ones are inserted by tilting the elements to the side and fastening them from the bottom.

It is recommended to first cast a foundation block and 2/3 of the first Kub® shift. If one choose traditional sole the first Kub element needs to be fixed to concrete sole with wood lumber 48x48 mm. Every shift is built in the same direction as the first one, and adjusted towards the same corner. When adjusting it is possible that some knobs will have to be removed in order to make the elements join completely. Turn corners oppositely in every other shift in order to ensure overlap. When cutting out windows and doors, extra space is included for placing the base cap mouldings. These add 100 mm, and this is added on both sides as well as the top and the bottom, where base cap mouldings are used.

NB! Use locking brackets where the elements are cut and wherever else they are needed, and max 1 floor should be cast at a time.

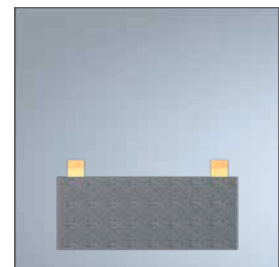
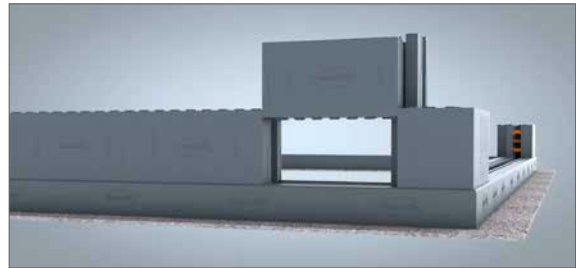
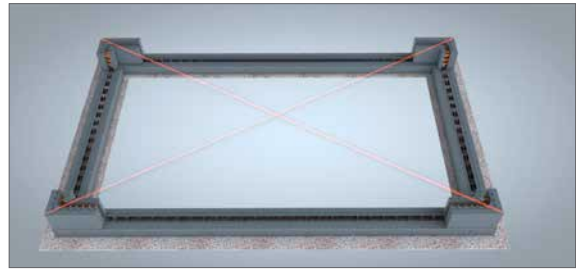

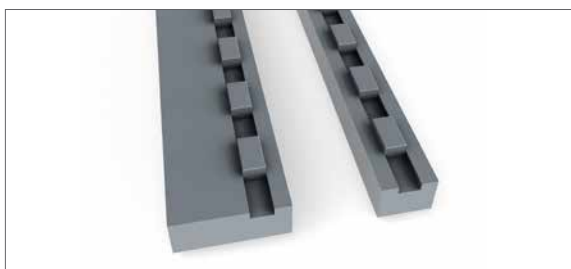
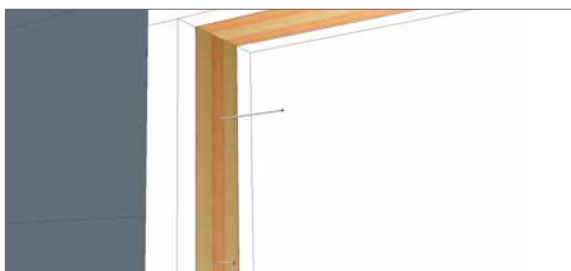

Element frame:

Adapt the element frames to window and door openings by cutting with a handsaw.

Element frames are cut and mounted on a wooden frame of 48x198 mm. Insert wooden frames with base cap mouldings in all openings and mark them horizontally and vertically. Feel free to drill a hole at the bottom of the openings in order to secure the concrete filling underneath windows and doors.

The wooden frames are anchored in the concrete by inserting 6" nails which fasten when filling in the concrete. Pre-drilling must be done before inserting the nails. In a 1.2x1.2 window 3 pcs. nails are used on every side.

Increase the number at larger cut-outs.

It is recommended to use treated wood in framed elements. Place windows and doors so the timber is not visible.

Top strips:

It may be necessary to adjust the height of the wall, or other places such as outside the floor separator, or when carving out window openings. The top strips are adapted to a width of 100 and 200 mm and have a height of 75 mm. Only one list is to be used at a time height-wise, except when used for insulation outside floor separators with extra bracing on the outside.

NB! When using top strips to build up height it is recommended to strengthen it further, as the concrete pressure may push the wall out a little in the area of the wall without plastic rods.

Reinforcing a Kub® wall – minimum reinforcement

Rebars:

Rebars of the type B500NC must be used according to NS 3576 and NS-EN 1002. The reinforcements shall have at least 500mm overlap when joined, in corners, angles should be at least 750 mm each way.

Reinforcing walls:

Kub® wall systems are reinforced with horizontal reinforcement of 2 pcs. Ø10 mm rebar at the top of every shift, c/c 600mm. For the two top shifts, additional 2 pcs. Ø10 mm must be inserted into the bottom part of the Kub® element in order to achieve c/c 300 mm for the horizontal reinforcement.

If the construction system is used for more than one storey, all walls must additionally have a vertical minimum reinforcement of Ø10 mm rebar placed in the centre at a distance of c/c 300 mm.

Foundation:

The Kub® wall system shall normally be placed on a reinforced concrete base, for example cast in Sundolitt Kub® Footing block. The foundation is reinforced horizontally with 2 pcs Ø12 mm rebar. Walls with ground pressure shall have a concrete floor as horizontal counter hold at the bottom. At fill heights of more than 1.0 m, the concrete floor must be cast in direct contact with the wall's concrete core at least through contact points with a width of 100 mm in a mutual distance of max. c/c 1.0 m.

Supportive reinforcement:

The wall system is vertically connected to the foundation with Ø10 mm rebar c/c 300 mm, from the foundation and at least 1200 mm over the floor, and shall be anchored 500 mm in foundation concrete, could be necessary to bend it.

Around cut-outs:

Openings in the wall for windows and doors should also be reinforced with a minimum of 2 pcs Ø12 mm rebar above, under and along the side edges, with an anchoring length of at least 500 mm at each side. With large cut-outs larger than 1.2 m or with point loads, the amount of reinforcement must be particularly calculated. See more information on page 10.

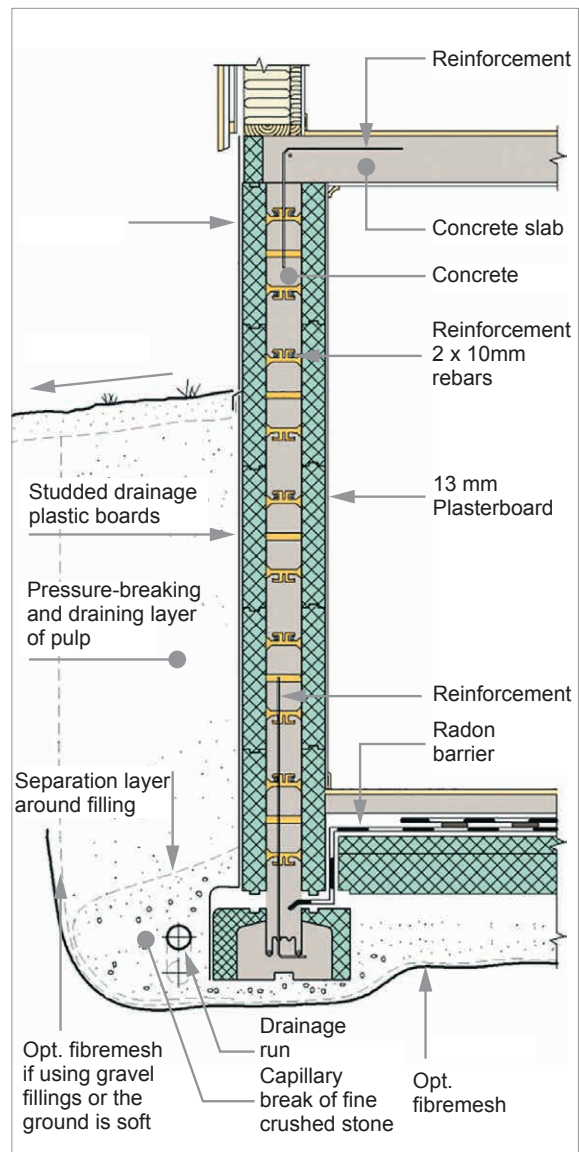

Foundation depth

Between support walls (m)	≤ 6.0	≤ 6.0	≤ 6.0	≤ 7.0	≤ 8.0
Filling height (m)	≤ 2.0	≤ 2.5	≤ 3.0	≤ 2.4	≤ 2.4
Minimum depth top floor to bottom foundation (mm)	400	650	800	750	900

Reinforcing when backfilling – two methods

Planning assumptions:

Walls against the terrain is assumed to be braced with cast transverse walls as described on page 10; or towards floor separators as a rigid plate. Fill height ≤ 3.0 m, and terrain fall 1:50 at least 3 m from the wall.

Outside the wall there must be a pressure-breaking and draining layer of fine crushed sand, gravel or sand that are protecting from water pressure towards the wall, which will lead the water unobstructed towards the drain hose.

Method 1

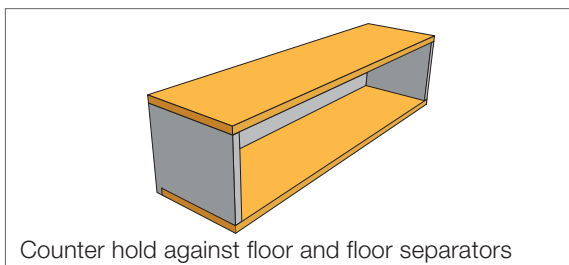

Counter hold against floor and floor separators

Wall supported against the floor and floor separator:

Additional reinforcement:

Outside walls towards the terrain can be made so that they are supported and tensioned towards floor separators made as a rigid plate, usually concrete elements or concrete, above and fastened to the bottom foundation without using supportive walls. This requires extra reinforcement in addition to

the general reinforcement as described above. With an exterior fill height up to 2.3 m (over the concrete foundation) the wall is reinforced vertically with $\varnothing 10$ mm rebar c/c 300 mm on the inside of the wall and the wall must also be anchored with reinforcement angles of $\varnothing 10$ mm rebar c/c 300mm to the overlying cover. With this solution, horizontal forces from the ground pressure against the wall must be included in the total assessment of the building's stability. Backfilling of masses against the exterior wall is carried out after the walls and floor separators are cast and sufficiently hardened.

Connection to floor separators:

The cover shall be placed at minimum 100 mm towards the wall's concrete core. For details we refer to Byggforskserien Byggdetaljer 523.111.

Method 2

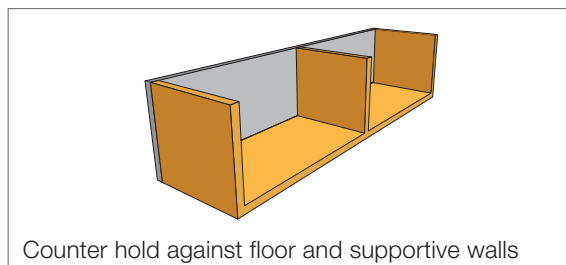

Counter hold against floor and supportive walls

Wall supported against floor and supportive walls c/c ≤ 6 m

Reinforcement at fill height ≤ 2.0 m

The wall is reinforced as shown on page 8.

Reinforcement at fill height $> 2.0 \leq 3.0$ m

Reinforcement for fill heights of up to 3 m is described in Sintef Teknisk Godkjenning No. 2216.

Wall supported against floor and supportive walls c/c > 6 m ≤ 8 m

Reinforcement at fill height ≤ 2.4 m

	Reinforcement (mm)	
	Distance between supportive walls	
	7 meters	8 meters
Vertical anchoring to the foundation, outside wall	$\varnothing 12$ c/c 300, 1.5 m up to the wall	$\varnothing 12$ c/c 150, 1,5 m up to the wall
Horizontal reinforcement on both sides	$\varnothing 12$ c/c 600 1)	$\varnothing 12$ c/c 600 2)
Vertical reinforcement at wall height, interior side	$\varnothing 10$ c/c 450 mm	$\varnothing 10$ c/c 450 mm

1) c/c 300 mm in the two upper shifts (that is from the top four reinforcement layers). $\varnothing 12$ is replaced with $\varnothing 16$ in the upper reinforcement layer of the top shift.

2) c/c 300 mm in the two upper shifts (that is, the top four reinforcement layers). $\varnothing 12$ is replaced by $\varnothing 16$ in both the top and bottom reinforcement layer of the top shift.

Reinforcing supportive walls and beams above openings

Planning assumptions:

Short supportive wall with height above basement floor ≤ 3 m.

Filling materials against the wall shall be crushed stone, sand or gravel. Lighter masses may also be used. The supportive wall must be a reinforced concrete wall cast in direct contact with the concrete part of the basement wall. The wall is placed on the foundation, and the floor shall be cast in direct contact with the supportive wall. The distance between supportive walls is described on page 9, and one or more supportive walls may be used.

Reinforcing supportive walls:

The supportive wall is reinforced horizontally with 2 pcs $\text{Ø}12$ rebar c/c 300 mm. Brackets are used at the end of the supportive wall horizontally c/c 300 mm.

The supportive wall is reinforced vertically with 2 pcs (both sides) $\text{Ø}10$ c/c 300 mm. In addition it is reinforced additionally at the end of the supportive wall with 4 pcs $\text{Ø}12$ mm vertically, placed in overlap with the protruding supportive reinforcement from the foundation.

The supportive wall is anchored horizontally with angle brackets into the KUB wall with $\text{Ø}12$ mm c/c 300 mm.

Reinforcing the foundation:

The foundation is reinforced horizontally with $\text{Ø}10$ rebar c/c 250 mm equally in both directions (crossplied). The supportive reinforcement from the foundation into the supportive wall shall also be mounted, with $\text{Ø}12$ mm c/c 300 mm and at least 500 mm into the supportive wall.

Beams above openings:

For light openings beyond 1200 mm it must be reinforced additionally with regards to line loads. Contact the technical department with Brødr. Sunde AS to receive calculations, witch are made for widths up to 3 meters.

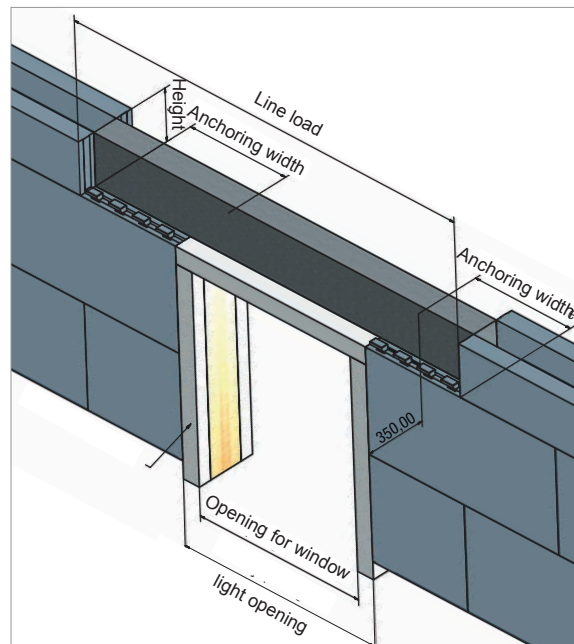
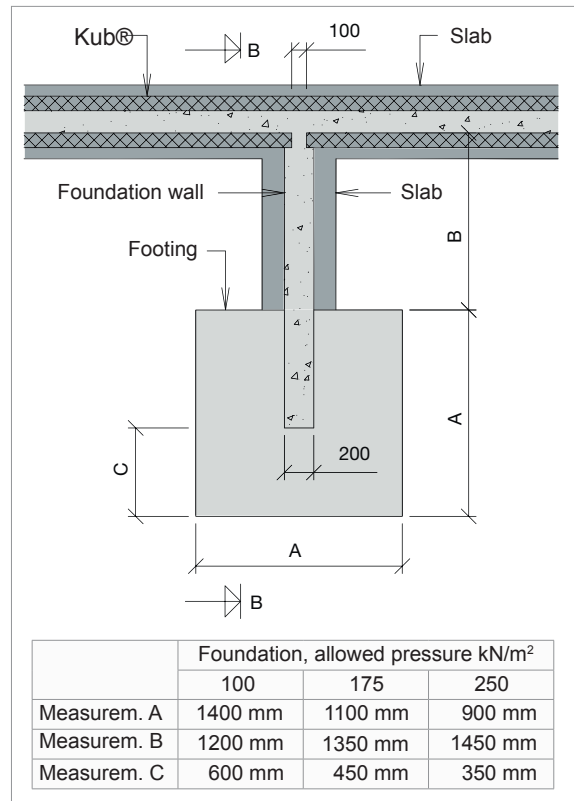

Bracing the wall / casting

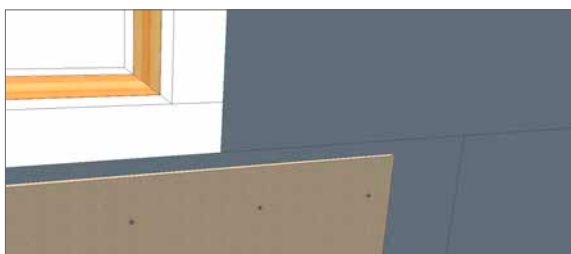
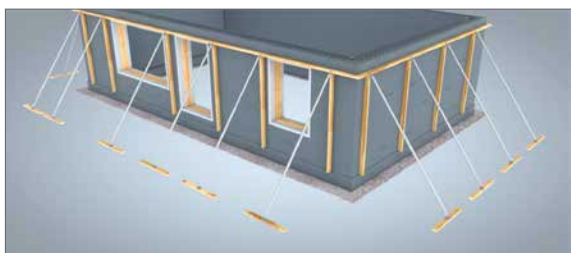

Concrete recipe: (Quantity calculation page 14)

- B30
- Concrete aggregates, maks 16 mm
- Large aggregate, to be reduced by 25%
- Slump test level 18-20 cm

NB! A concrete vibrator should not be used.

We recommend that the slump level is controlled at the building site in order to ensure compliance with the recipe. Too soft pulp leads to significantly higher pressure and risk of damages. Too firm pulp may lead to air pockets some places.

Shoring the walls:

Finally alignment and bracing of all walls are carried out. Bracing is done with aluminium rods or 48x98 mm lumber. Put on vertical bracing externally or internally at all corners and all cut-outs, elsewhere with a distance of around 2 m. To be fastened in the plastic rods with screws of at least 140mm. In addition a horizontal 48x98 mm is added at

the top over the vertical bracing. Diagonal are fastened at the top of the wall, as well as into the ground in order to keep the wall firmly in vertical.

NB! It should be further strengthened with plywood plates or studs wherever there are weak spots, joints, or wherever needed towards cut-outs. If the distance from plastic rods to cut-outs is more than 100 mm, it shall be additionally secured. Shingle shall be raked towards the foundation on both sides in order to secure the foundation and keep it positioned.

Casting the wall:

The concrete filling is done with a mobile concrete pump. In order to reduce the load on the wall the pump is run at reduced pressure. Start filling in one of the corners and keep going around until you have finished a round. The recommended casting speed is 1 meters (height) per hour, and maximum 2.4 m at a time.

The wall must be cast in two stages by building the foundation + one shift of Kub® elements and casting this first, see page 6. This enables you to fill inn masses, finish the piping in the foundation and insulate, as well as casting the plate. Cover the knobs of the Kub® element with compensation lists or plastic before casting if you will build further upwards after casting. Remove concrete residue immediately after casting.

NB!

Kub® as formwork:

Be aware that Kub® elements during the construction stage must be treated as formwork, and normal principles for concrete work is assumed. The plastic rods of the Kub® are over-dimensioned in order to handle the concrete pressure, but if they suffer damage during transport or at the construction site, the tensile strength will be reduced and it might lead to local out-breaks when filling the concrete. If this should happen, the concrete filling is stopped, the piece of EPS that broke out is re-inserted, det stemples av and the concrete filling continues. Lowest recommended temperature for casting is -5 °C.

Supplementary work

Casting the floor

For walls exposed with ground pressure, the concrete floor must be cast in direct contact with the wall concrete. It is enough with point-wise contact in form of a cut-out of 100 mm width at the same height as the concrete floor every meter.

Filling/load

It is recommended that the concrete gets at least 4 weeks to dry/harden, depending on among others the thermal conditions, before backfilling externally and the wall is loaded. Any supportive walls, floor separators and floor plates that contributes as counter holds must also be finished so that they have gotten their calculated strength.

Surface treatment

Above terrain the wall can be finished with 8 mm system/ fibre reinforced plaster with technical approval applying to the usage and geographical area in question. The recommended drying time before screeding is 4-6 weeks. Alternatively the exterior wall can be clad with GU-plaster, studs and cladding. Such cladding is anchored in the concrete.

Below the terrain the knodded concrete raft foundation is fitted in plastic with end moulding at ground level. The Kub® wall shall be finalized both externally and internally in order to achieve the correct fire resistance and protection against humidity.



Internal treatment

All EPS material shall be covered by min. one layer of 13 mm plasterboards fastened to the support system of the construction, with fixing means of metal or to the cast plastics of the Kub® elements. The joints are sealed with strips and plaster. This provides REI30.

Alternatively 15 mm wooden panels, 12 mm chipboards, 1 mm medium density fibreboards or 9 mm plywood plates may be used. But then these must be fitted to a wooden stud of at least 50 mm with mineral wool insulation laid between the studs. The studs are fastened in the support system of the constructions or the plastics.

Internal damp proof course

When using plaster directly on EPS, internal damp proof course are not needed. When using studs, damp proof course must be fitted between Kub® and lekt.

Wet rooms and Kub®

In wet rooms a membrane and tiles may be added to the Kub® elements. It is also possible to screed on the Kub® elements before adding the membrane and tiles. For details please see construction detail 543.506 in Bygghorskerien.

Floor separators and Kub®

When using concrete cover or hole cover, the cover shall be cast or lifted in place with an arrangement of at least 100 mm towards the concrete core of the Kub® wall. When using wooden joists, any corbelling may constitute the same as the width of the wooden joist.

See sketch for example of construction.

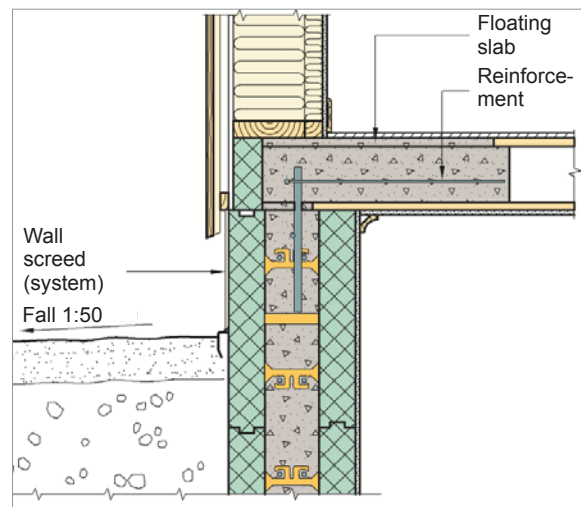

Example of attachment to floor separators when using concrete cover

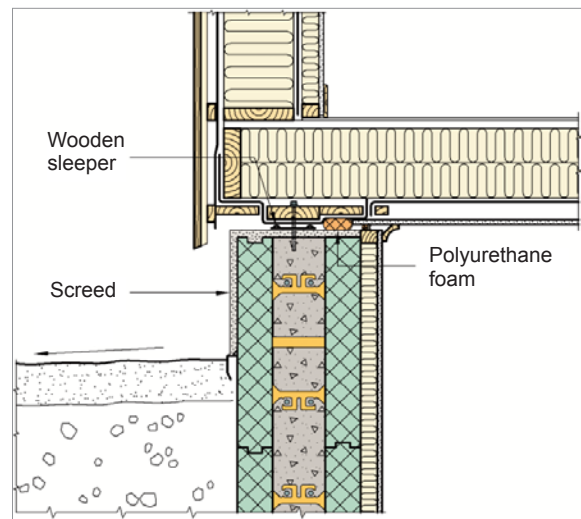

Example of attachment to floor separators when using concrete wooden joist.

Remember this!

Bracing and securing the walls

Bracing and alignment is done to ensure that the wall stays upright when filling in the concrete, as well as to avoid breakouts in the wall. One side of the wall shall be shored to keep the wall in plumb, and strut is anchored to the ground in order to keep it positioned both ways. Wherever the elements are cut, there might be weak spots, particularly around cut-outs for windows and doors, in which case it is important to examine it carefully to strengthen it with plywood/ studs wherever needed. **This must be done before starting to fill in concrete.**

If the construction of Kub® is done over several days, and there is danger of strong winds, the wall must be secured as in progress while building upwards. This is done by affixing 48x98 wooden studs in the plastic rods of the Kub® elements and using diagonal struts for securing the wall.

Safety

HSE shall always be maintained on a construction site, and the correct use of scaffolding/work platforms and protective gear is very important in order to avoid injuries and damages to persons and equipment. The EPS material in Kub® is flammable insulation and must not be exposed to embers or flames during construction.

Goods delivery

Always check that the goods do not have transport damages or other faults, and that the number is correct, before using the products.

Direct sunlight

Kub® elements must not be covered by damp proof course or other types of plastic (not the supplied packaging) if there is any danger of direct sunlight. This may lead to high temperatures of the Kub® surface and risk of deformation.

Storing the elements

On the construction site and during transport, all Kub® elements are stored in an upright position. This is done to avoid incorrect impact on the plastic rods, which may lead to damaging them.

Construction during winter

It is not recommended to cast at temperatures below -5°C.



Kub® must be stored in upright position

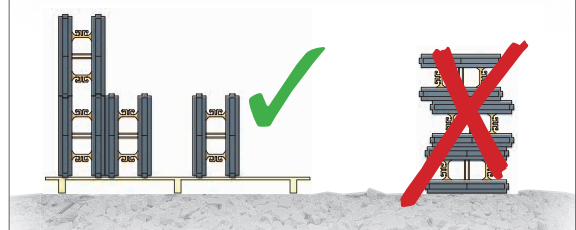

Plastic turns porous at low temperatures, which means that the elements must be handled carefully so that the cast plastic rods are not damaged. Remember that the elements always must be upright, and not on the side.

Quantity calculation materials

How much do I need:

Sundolitt Kub® construction system

Quantity calculation can be done by our consultants at ordre.norge@sundolitt.com, or you can do it yourself at www.sundolitt.no

Concrete:

In order to calculate the usage of concrete, these measurements are used.

- Foundation block 70 litres/m
- Kub® wall 150 litres/m²

Remember to subtract windows and doors and add a little for starting the concrete pump.

Reinforcement:

The amount of reinforcement depends on how many supportive walls, cut-outs etc. the building will have. See pages 8-10 for the basics of calculating amounts.

Wooden studs for shoring:

A horizontal 48x98 is fitted at the top of the wall, as well as vertically at around 2 m distance. Calculate the amount based on this. For a construction with a 50 m circumference you then need around 150 m 48x98. The amount of lumber is automatically calculated in our quantity calculation program on our website. It is sufficient to brace the wall on one side.





THE REGIONS

- NORTH/MIDDLE
- EAST
- SOUTH/WEST

Sunde as

P.b. 8115, Spjelkavik
NO-6022 Ålesund
Telephone: +47 70 17 70 00
e-mail: norway@sundolitt.com

www.sundolitt.no

Orders: Phone (70 17 70 00
E-mail: ordre.norge@sundolitt.com

